

BASIC FIRE DOOR REQUIREMENTS

TECHNICAL DATA SHEET No. 401

Fire door openings are classified by their locations in the building. The location determines the length of exposure protection required, based on the potential fire hazard of that particular area. The six opening classifications are shown below along with the six door ratings and the maximum amount of glass in square inches allowed for each door.

Label Classification	Location In Building	Maximum Glass Area
3 HOUR RATING	3 hour rated opening (Class A). Openings are in walls separating buildings or dividing a single building into fire areas. Doors for these openings require a fire protection rating of 3 hours.	100 square inches per leaf. See note 1.
1-1/2 HOUR RATING	1 1/2 hour rated opening (Class B). Openings are in enclosures of vertical communication through buildings. These could be stairwells or elevator shafts. While not a means of vertical communication, boiler room doors are generally categorized as Class "B" openings. Door for these areas require a fire protection rating of 1 1/2 hours, and glass areas may not exceed 100 square inches per individual door leaf except as noted below.	100 square inches per leaf. See note 2.
3/4 HOUR RATING	3/4 hour rated opening (Class C). Openings are in corridors and room partitions. Doors for these areas require a fire protection rating of 3/4 hour, and the glass area cannot exceed 1296 square inches per light with no dimension exceeding 54 inches except as noted below.	1296 square inches per light. Neither dimension to exceed 54". See note 2.
1-1/2 HOUR RATING	1 1/2 hour rated opening (Class D). Openings are in exterior walls which are subject to severe fire exposure from the outside of the building. Doors for these areas require a fire protection rating of 1 1/2 hours.	See note 3.
3/4 HOUR RATING	3/4 hour rated opening (Class E). Openings are in exterior walls which are subject to moderate or light fire exposure from the outside of the building. A typical example would be a door leading to an exterior fire escape. Doors for these openings require a fire protection rating of 3/4 hour with glass areas not exceeding 1296 square inches per light with no dimension exceeding 54 inches.	1296 square inches per light. Neither dimension to exceed 54". See note 3.
20 MINUTE	20 minute fire rated door frame assemblies are normally found in interior partitions and are intended for installation with 20 minutes fire rated doors of the single swing, swing in pairs, or double egress types.	1296 square inches per light. Neither dimension to exceed 54". See note 2.
<p>Note 1. 100 square inches when using Firelite glass. Neither dimension exceeding 33".</p> <p>Note 2. Except when using Pemko fire glazing compound. See U.L. procedure or consult factory.</p> <p>Note 3. Consult with local authority having jurisdiction for allowable glass.</p>		

Revised 9/14

Republic provides a comprehensive line of 1-3/8" and 1-3/4" thick labeled doors and frames to meet every requirement for fire protection. The construction conforms to fire door procedure whether the doors are furnished with labels or not. Since label requirements vary throughout the country, local authorities having jurisdiction regarding the use of label opening should be consulted during the design and planning stages.

Underwriters Laboratories (UL)

Doors and frames approved by the Underwriters Laboratories, Inc. have been investigated, fire tested in accordance with UL10B, UL10C, UBC7-2 and ASTM E-152 and produced under the Underwriters Laboratory factory inspection and labeling service program. The attachment of the Underwriters Laboratories Listing or Classification mark indicates that the material has been constructed to comply with the manufacturing specifications as described in the Underwriters Laboratories Follow-Up Service Procedures Program.

Warnock Hersey (WH)

Doors and frames bearing the Warnock Hersey Label have been successfully fire tested in accordance with UL10B, UL10C, UBC7-2 and ASTM E-152. The Warnock Hersey Listing or Classification mark indicates that the material has been constructed to comply with the manufacturing specifications as described in Warnock Hersey's Follow-Up Service Procedures Program.

Revised 9/14

**SUGGESTED PROCEDURES FOR THE
SELECTION OF FIRE DOORS & FRAMES****TECHNICAL DATA
SHEET No. 403**

- A. Determine the appropriate building code.
- B. Check and fulfill the fire insurance company's requirement for the specific building.
- C. Establish which label (UL or WH) is acceptable to local authorities having jurisdiction (LAHJ).
- D. Basic Fire Door Requirements--
Use this checklist:
1. A fire door must have a Classification mark attached. (metal or mylar)
 2. A fire door frame must have a Listing Mark on the hinge jamb - one on each hinge jamb of a double opening. A fire door frame may be embossed with a UL Listing Mark if acceptable with the LAHJ.
 3. A fire door must be self-closing and self-latching.
 4. Door closers or UL Listed spring hinges are required on all fire doors.
 5. An automatic closing door must have a separate, Listed, fail-safe-door-holder/release device or a hold-open mechanism which may be an integral part of the basic closing device, provided the hold-open mechanism is released by one or a combination of automatic fire detectors acceptable to the authority having jurisdiction.
 6. A fire door must be free of any obstructions which would prevent the door from operating properly, i.e. wedge door stops, chains, hook-backs, etc.
 7. Only listed fire door hardware shall be used.
 8. A fire door must have steel hinges.
 9. A pair of doors must have an overlapping steel astragal for 3 hour rated locations.
 10. A pair of doors may be furnished without an astragal for 1-1/2 hour and 3/4 hour locations providing the opening meets one of the following:
 - a. Each leaf is equipped with a vertical rod exit device or rim exit device (with hardware mullion).
 - b. The door leaves have one mortise and one vertical rod exit device with open or closed back strike.
 - c. The active door leaf has a mortise or cylindrical lock with open or closed back strike; inactive door has flush bolts.
 11. Fire doors with glass lites:
 - a. Reinforcement channel must be provided except as noted on Tech Data Sheet 404.
 - b. Glass frame and glazing bead must be steel.
 - c. Glass must be 1/4" thick wire glass or other UL Listed glazing material.
 - d. Maximum allowable glass area (subject to approval of LAHJ):
 - 3 hours, 100 sq. in. per door leaf (Firelite)
 - 1-1/2 hours, 100 square inches per door leaf
 - 3/4 hour, 1296 square inches per door lite
 12. Fire doors with fusible link louvers:
 - a. A Listed louver must be used. Door may be furnished with louver installed at door manufacturer's plant or cutout reinforced and labeled for field installation.
 - b. Louvers can be furnished in 1-3/4", 1-1/2 hour and 3/4 hour label flush doors only (no louver and glass lite combinations permitted).
 - c. Maximum door size with louver is 3'6" x 7'2".
 - d. Only one louver per door leaf. Maximum louver size is 24" x 24".
 - e. Louvers are not permitted to be installed in doors with Fire Exit Device Hardware.
- E. For maximum fire protection, NFPA-80 should be used as a guideline.

Revised 9/14

FIRE DOORS WITH GLASS

TECHNICAL DATA SHEET No. 404

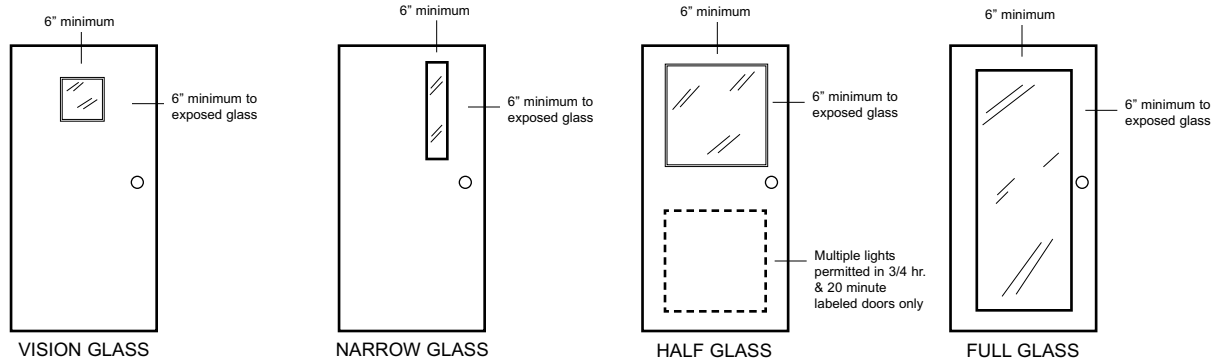

DOOR TYPE	MAXIMUM SIZE	VISION GLASS	NARROW GLASS	HALF GLASS	FULL GLASS
DE 820	3072	3 Hr., 1-1/2 Hr., 3/4 Hr., 20 Min.	3, 1-1/2 Hr., 3/4 Hr., 20 Min.	3/4 Hr., 20 Min.	20 Min Without Hose Stream
DE 818	3072	3 Hr., 1-1/2 Hr., 3/4 Hr., 20 Min.	3, 1-1/2 Hr., 3/4 Hr., 20 Min.	3/4 Hr., 20 Min.	20 Min Without Hose Stream
DM 820	3072	3 Hr., 1-1/2 Hr., 3/4 Hr., 20 Min.	3, 1-1/2 Hr., 3/4 Hr., 20 Min.	3/4 Hr., 20 Min.	20 Min Without Hose Stream
DL/DE 420	3072	3 Hr., 1-1/2 Hr., 3/4 Hr., 20 Min.	3, 1-1/2 Hr., 3/4 Hr., 20 Min.	3/4 Hr., 20 Min.	20 Min Without Hose Stream
DL/DE 418	40100	3 Hr., 1-1/2 Hr., 3/4 Hr., 20 Min.	3, 1-1/2 Hr., 3/4 Hr., 20 Min.	3/4 Hr., 20 Min.	20 Min Without Hose Stream
DL/DE 416	40100	3 Hr., 1-1/2 Hr., 3/4 Hr., 20 Min.	3, 1-1/2 Hr., 3/4 Hr., 20 Min.	3/4 Hr., 20 Min.	20 Min Without Hose Stream
DL/DE 420 (Insulated)	3072	3 Hr., 1-1/2 Hr., 3/4 Hr., 20 Min.	3, 1-1/2 Hr., 3/4 Hr., 20 Min.	3/4 Hr., 20 Min.	Not Available
DL/DE 418 (Insulated)	4080	3 Hr., 1-1/2 Hr., 3/4 Hr., 20 Min.	3, 1-1/2 Hr., 3/4 Hr., 20 Min.	3/4 Hr., 20 Min.	Not Available
DL/DE 416 (Insulated)	4080	3 Hr., 1-1/2 Hr., 3/4 Hr., 20 Min.	3, 1-1/2 Hr., 3/4 Hr., 20 Min.	3/4 Hr., 20 Min.	Not Available
DL/DE 420 (Temp. Rise)	3072	3 Hr., 1-1/2 Hr., 3/4 Hr., 20 Min.	3, 1-1/2 Hr., 3/4 Hr., 20 Min.	Not Available	Not Available
DL/DE 418 (Temp. Rise)	4080	3 Hr., 1-1/2 Hr., 3/4 Hr., 20 Min.	3, 1-1/2 Hr., 3/4 Hr., 20 Min.	Not Available	Not Available
DL/DS 418	50100	3 Hr., 1-1/2 Hr., 3/4 Hr., 20 Min.	3, 1-1/2 Hr., 3/4 Hr., 20 Min.	3/4 Hr., 20 Min.	Not Available
DL/DS 416	50100	3 Hr., 1-1/2 Hr., 3/4 Hr., 20 Min.	3, 1-1/2 Hr., 3/4 Hr., 20 Min.	3/4 Hr., 20 Min.	Not Available
DM 420	3072	3 Hr., 1-1/2 Hr., 3/4 Hr., 20 Min.	3, 1-1/2 Hr., 3/4 Hr., 20 Min.	3/4 Hr., 20 Min.	20 Min Without Hose Stream
DM 418	4070	3 Hr., 1-1/2 Hr., 3/4 Hr., 20 Min.	3, 1-1/2 Hr., 3/4 Hr., 20 Min.	3/4 Hr., 20 Min.	20 Min Without Hose Stream
UNIFIT™	4080	3 Hr., 1-1/2 Hr., 3/4 Hr., 20 Min.	3, 1-1/2 Hr., 3/4 Hr., 20 Min.	3/4 Hr., 20 Min.	20 Min Without Hose Stream

- Vision Glass - exposed glass area is not to exceed 100 square inches with no dimension exceeding 33".
- 3-hour doors with light must incorporate Firelight or Firelight Plus glazing.
- Narrow Glass - exposed glass area is not to exceed 100 square inch with no dimension exceeding 33".
- Half Glass - exposed glass area is not to exceed 1296 square inch with no dimension exceeding 54".
- Full Glass - exposed glass area is not to exceed 2994 square inch with the width not to exceed 35-13/16" and the height not to exceed 85-5/8".
- Doors may be provided for Listed glass kits to be installed at the job site. A supplemental marking is required specifying which manufacturer's glass kit is to be used. Reinforcing channels must be provided unless All Metal Stamping Model No. 110UL kit or Anemostat Listed kit with HM clips is used.
- Other approved glass kits for use in RBP doors are manufactured by Leslie-Locke and Air Louver.
- See Technical Data Sheet 405 for Unifit™ door limitations.

Revised 9/14

LABELED DOOR SIZES AND TYPES

TECHNICAL DATA SHEET No. 405

Single Doors

- Doors may be fabricated from cold rolled or galvanized steel.
- 20 gage, 18 gage or 16 gage "Unifit" Doors can be labeled after the appropriate preparations are added by an authorized U.L. or W.H. warehouse or distributor. Maximum size 20 gage Unifit door is 3072.
- DE 418 and 420 Doors may be full flush or (6) panel embossed design. Six panel doors are available as insulated only.

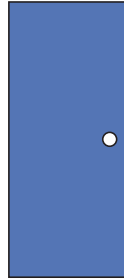

Door Type	Maximum Size	Rating Available
DE 820	3072 (914 x 2184)	1 1/2 Hr., 3/4 Hr., 20 Min.
DE 818	3072 (914 x 2184)	1 1/2 Hr., 3/4 Hr., 20 Min.
DM 820	3072 (914 x 2184)	1 1/2 Hr., 3/4 Hr., 20 Min.
DE & DL 420	4080 (1219 x 2438)	3 Hr., 1 1/2 Hr., 3/4 Hr., 20 Min.
DE & DL 418	40100 (1219 x 3048)	3 Hr., 1 1/2 Hr., 3/4 Hr., 20 Min.
DE & DL 416	40100 (1219 x 3048)	3 Hr., 1 1/2 Hr., 3/4 Hr., 20 Min.
DE 414	40100 (1219 x 3048)	3 Hr., 1 1/2 Hr., 3/4 Hr., 20 Min.
DE 420 (Insulated)	3072 (914 x 2184)	3 Hr., 1 1/2 Hr., 3/4 Hr., 20 Min.
DE & DL 418 (Insulated)	4080 (1219 x 2438)	3 Hr., 1 1/2 Hr., 3/4 Hr., 20 Min.
DE & DL 416 (Insulated)	4080 (1219 x 2438)	3 Hr., 1 1/2 Hr., 3/4 Hr., 20 Min.
DE & DL 420 (Temp. Rise)	3072 (914 x 2184)	3 Hr., 1 1/2 Hr., 3/4 Hr.
DE & DL 418 (Temp. Rise)	4080 (1219 x 2438)	3 Hr., 1 1/2 Hr., 3/4 Hr.
DS 418	4080 (1219 x 2438)	3 Hr., 1 1/2 Hr., 3/4 Hr., 20 Min.
DS 416	50100 (1524 x 3048)	3 Hr., 1 1/2 Hr., 3/4 Hr., 20 Min.
DS 414	50100 (1224 x 3048)	3 Hr., 1 1/2 Hr., 3/4 Hr., 20 Min.
DM 420	4070 (1219 x 2134)	3 Hr., 1 1/2 Hr., 3/4 Hr., 20 Min.
DM 418	4070 (1219 x 2134)	3 Hr., 1 1/2 Hr., 3/4 Hr., 20 Min.
UNIFIT™	4080 (1219 x 2438)	3 Hr., 1 1/2 Hr., 3/4 Hr., 20 Min.

Dutch Doors

Door Type	Maximum Size	Rating Available
DL 420	3072 (914 x 2184)	3 Hr., 1 1/2 Hr., 3/4 Hr., 20 Min.
DL 418	4072 (1219 x 2184)	3 Hr., 1 1/2 Hr., 3/4 Hr., 20 Min.
DE 420	3072 (914 x 2184)	3 Hr., 1 1/2 Hr., 3/4 Hr., 20 Min.
DE 418	4072 (1219 x 2184)	3 Hr., 1 1/2 Hr., 3/4 Hr., 20 Min.

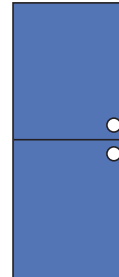

- Dutch Doors must have an astragal attached to the top leaf.
- A half shelf is optional.
- Lock provision may be for either cylindrical or mortise lock sets.
- Louvers are not permitted.
- Glass lights are permitted in 1-1/2 hr., 3/4 hr. and 20 min. rated doors.

Double Egress Doors

- Surface mounted or concealed vertical rod device hardware is required on each leaf.
- All series doors exceeding 1 1/2 hr. rating require an astragal.
- Glass lights are permitted up to 100 sq. in. of exposed glass per leaf in 1 1/2 hr. rated doors and 1296 sq. in. of exposed glass per light in 3/4 hr. rated doors.

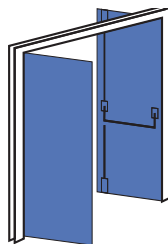

Door Type	Maximum Size	Rating Available
DM 418	8080 (2438 x 2438)	3 Hr., 1 1/2 Hr., 3/4 Hr., 20 Min.
DE & DL 420	8080 (2438 x 2438)	3 Hr., 1 1/2 Hr., 3/4 Hr., 20 Min.
DE & DL 418	8080 (2438 x 2438)	1 1/2 Hr., 3/4 Hr., 20 Min.
DE & DL 416	8080 (2438 x 2438)	1 1/2 Hr., 3/4 Hr., 20 Min.
DE 418 (Insulated)	8080 (2438 x 2438)	3 Hr., 1 1/2 Hr., 3/4 Hr., 20 Min.
DE 420 (Insulated)	8080 (2438 x 2438)	3 Hr., 1 1/2 Hr., 3/4 Hr., 20 Min.

Doors with Fusible Link Louvers

Door Type	Maximum Size	Label Available
DM 420	3072 (914 x 2184)	1 1/2 Hr., 3/4 Hr.
DL 418	3672 (914 x 2184)	1 1/2 Hr., 3/4 Hr.
DE & DL 420	3072 (1067 x 2184)	1 1/2 Hr., 3/4 Hr.
DE & DL 418	3672 (1067 x 2184)	1 1/2 Hr., 3/4 Hr.
DE 416	3672 (1067 x 2184)	1 1/2 Hr., 3/4 Hr.



- Maximum louver size: one 24" (610) x 24" (610) per door leaf. Not available with glass lites or fire exit hardware.

Revised 9/14

LABELED DOOR SIZES AND TYPES (CONTINUED)

TECHNICAL DATA SHEET No. 405a

Pairs of Doors without Astragal

Mortise and vertical rod exit devices with open or closed back strike

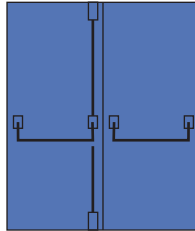

Surface or concealed vertical rod exit device on each leaf (two active leaves) or rim exit device with hardware mullion (two active leaves).

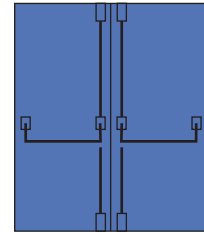

Mortise or cylindrical lock with open or closed back strike and flush bolts

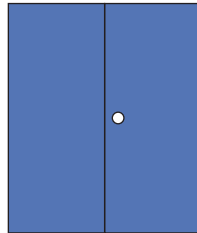

Door Type	Maximum Size	Rating Available
DM 420	8070 (2438 x 2134)	1 1/2 Hr., 3/4 Hr., 20 Min.
DM 418	8070 (2438 x 2134)	1 1/2 Hr., 3/4 Hr., 20 Min.
DE & DL 418	80100 (2438 x 3048)	1 1/2 Hr., 3/4 Hr., 20 Min.
DE & DL 416	80100 (2438 x 3048)	1 1/2 Hr., 3/4 Hr., 20 Min.
DS 418	80100 (2438 x 3048)	1 1/2 Hr., 3/4 Hr., 20 Min.
DS 416	80100 (2438 x 3048)	1 1/2 Hr., 3/4 Hr., 20 Min.
DE 420 (Temp. Rise)	6072 (1829 x 2184)	1 1/2 Hr., 3/4 Hr.
DE 418 (Temp. Rise)	8072 (2438 x 2184)	1 1/2 Hr., 3/4 Hr.
DE & DL 418 (Insulated)	8080 (2438 x 2438)	1 1/2 Hr., 3/4 Hr., 20 Min.
DE & DL 416 (Insulated)	8080 (2438 x 2438)	1 1/2 Hr., 3/4 Hr., 20 Min.
UNIFIT™	8080 (2438 x 2438)	1 1/2 Hr., 3/4 Hr., 20 Min.

Pairs of Doors with Astragal

Mortise or cylindrical lock with open or closed back strike and flush bolts

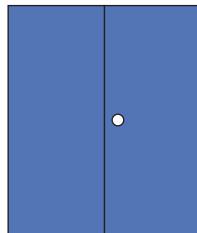

Door Type	Maximum Size	Rating Available
DE 820	6072 (1829 x 2184)	1 1/2 Hr., 3/4 Hr., 20 Min.
DE 818	6072 (1829 x 2184)	1 1/2 Hr., 3/4 Hr., 20 Min.
DM 820	6072 (1829 x 2184)	1 1/2 Hr., 3/4 Hr., 20 Min.
DE & DL 420	8080 (2438 x 2438)	3 Hr., 1 1/2 Hr., 3/4 Hr., 20 Min.
DE & DL 418	80100 (2438 x 3048)	3 Hr., 1 1/2 Hr., 3/4 Hr., 20 Min.
DE & DL 416	80100 (2438 x 3048)	3 Hr., 1 1/2 Hr., 3/4 Hr., 20 Min.
DE 414	80100 (2438 x 3048)	3 Hr., 1 1/2 Hr., 3/4 Hr., 20 Min.
DE & DL 420 (Insulated)	6072 (1829 x 2184)	3 Hr., 1 1/2 Hr., 3/4 Hr., 20 Min.
DE & DL 418 (Insulated)	8080 (2438 x 2438)	3 Hr., 1 1/2 Hr., 3/4 Hr., 20 Min.
DE & DL 416 (Insulated)	8080 (2438 x 2438)	3 Hr., 1 1/2 Hr., 3/4 Hr., 20 Min.
DE 420 (Temp. Rise)	6072 (1829 x 2184)	3 Hr., 1 1/2 Hr., 3/4 Hr.
DE 418 (Temp. Rise)	8080 (2438 x 2438)	3 Hr., 1 1/2 Hr., 3/4 Hr.
DS 418	80100 (2438 x 3048)	3 Hr., 1 1/2 Hr., 3/4 Hr., 20 Min.
DS 416	80100 (2438 x 3048)	3 Hr., 1 1/2 Hr., 3/4 Hr., 20 Min.
DM 420	8070 (2438 x 2134)	3 Hr., 1 1/2 Hr., 3/4 Hr., 20 Min.
DM 418	8070 (2438 x 2134)	3 Hr., 1 1/2 Hr., 3/4 Hr., 20 Min.
UNIFIT™	8080 (2438 x 2438)	3 Hr., 1 1/2 Hr., 3/4 Hr., 20 Min.

Note: See Technical Data Sheet 405 for Unifit™ door limitations.

Revised 9/14

LABELED FRAME SIZES AND TYPES

TECHNICAL DATA SHEET No. 406

Three Sided Frames

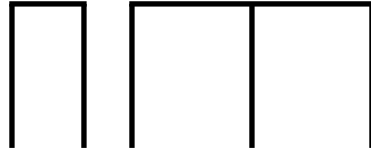

- Universal (ME) Frame
- Labeled frames may be of 16 gage, 14 gage, or 12 gage steel. (12 gage must be welded)
- Maximum door opening size: 40100 single, 80100 double.
- Maximum rating: 3 hours.
- Jamb Depths:
 - 3" (76) to 20" (508) Sgl. Rabbet
 - 4 1/2" (114) to 20" (508) Dbl. Rabbet
- Removable Fire Rated/UL approved hardware mullion permitted (up to three hour rating).
- Anchors may be shipped loose for up to 3 hr. frames, single or double opening.
- Based on welded construction.

- Drywall (MH) Frame.
- Labeled frames shall be of 16 or 14 gage steel.
- Maximum door opening size:
 - 4090 single, 8090 double.
- Maximum rating: 1 1/2 hours.
- Jamb Depths:
 - 3" (76) to 15" (381) Sg. Rabbet
 - 4 1/2" (114) to 15" (381) Dbl. Rabbet
- Based on knockdown construction.

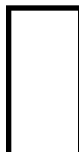

Multiple Opening Frame



- Labeled frames may be of 16 gage, 14 gage or 12 gage steel.
- Jamb Depth: 4 3/4" (121) to 20" (508).
- Maximum door opening size: 4080.
- Maximum frame size:
 - 98" (2489) high x 152" (3861) wide.
- Maximum Rating: 1 1/2 hours.
- Welded only.

Transom and Sidelight Frame

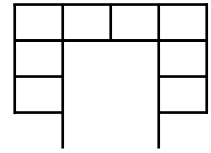
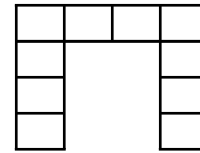
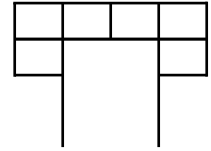

- Labeled frames may be of 16, 14 or 12 gage steel.
- Maximum frame size: 12'0" (3658) x 10'0" (3048) or 10'0" (3048) x 12'0" (3658) for masonry installations and 12'0" (3658) x 10'0" (3048) for drywall installations.
- Maximum door opening size: 4080 single, 8080 double.
- Jamb Depth: 4 3/4" (121) to 20" (508).
- Maximum exposed glass size: 1296 sq. in. with a maximum exposed width of 54" (1372).
- Maximum exposed panel size: 1296 sq. in. with a maximum transom width of 39" (991) and with a maximum height of 36" (914).
- Maximum rating: 1 1/2 hr. with panels, 3/4 hr. with glass for masonry or drywall installations.
- A stop height of 5/8" (16) is required for a maximum exposed glass of 1296 sq. in. When using special glazing compound 4704 sq. in.
- A stop height of 5/8" (16) is required for panels.
- Each jamb shall be provided with a sill anchor and (2) jamb anchors for heights up to and including 60" (1524) and an additional anchor for each additional 30" (762) of fraction thereof.
- Welded only

Double Egress Frames



- Labeled frames may be of 16 gage or 14 gage steel.
- Maximum door opening size: 8090.
- Maximum rating: 3 hours.
- A supplemental marking that reads: "Double egress fire doors by Republic Builders Products" is required to be placed next to the U.L. Listing mark.
- Frames may also be used with 20 minute or 3/4 hour classified wood doors. These frames require a supplemental marking that reads: "For use with classified double egress 20 minute or 3/4 hour doors" placed next to the U.L. Listing mark.

Revised 9/14

LABELED FRAME SIZES AND TYPES (CONTINUED)

TECHNICAL DATA SHEET No. 406a

Borrowed Light Frame

Typical Elevation

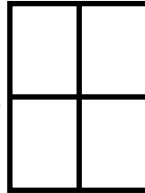

- Labeled frames may be of 16 gage or 14 gage or 12 gage steel.
- Maximum size: 9'4" (2845) wide x 8'10" (2692) high.
- Jamb Depth: 4 3/4" (121) to 20" (508).
- Face Dimensions: 1" (25) minimum - 2" (51) maximum.
- Maximum Rating: 3/4 hour.
- Maximum Exposed Glass: 2650 sq. in. with a maximum exposed width of 53" (1346) and maximum expanded height of 50" (1270).
- A stop height of 5/8"(16) is required for a maximum exposed glass of up to 2650 sq. in.
- Fire window frames are intended for installation in masonry walls or for installation in walls utilizing wood/steel studs.
- Each jamb shall be provided with a sill anchor and a jamb anchor for each 30" (762) of height or fraction thereof. An intermediate base anchor is required for frames over 4'0" (1219) wide.
- Must be welded.

20 Minute Frame with Lights

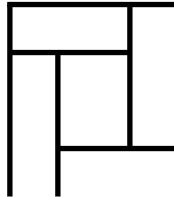

- Twenty minute type door frame with lights, fire tested without hose stream, for walls at least 3 1/2" (89) thick.
- ME/SE Series profile may be 12 gage, 14 gage or 16 gage steel.
- MH/SH Series profile may be 16 gage or 14 gage steel.
- Mitered corner connections are standard. 12 gage will be coped.
- Jamb Depth:
 - ME/SE profile - Sgl. Rbt. 3" (76) to 20" (508).
 - Dbt. Rbt. 4 1/2" (114) to 20" (508).
 - MH/SH profile -Sgl. Rbt. 3 1/2" (89) to 15" (381).
 - Dbt. Rbt. 4 1/2" (114) to 15" (381).
- The overall frame size shall not exceed 158 in. (4013) (13ft. 2 in.) in width and 139 in. (3531) (11 ft. 7 in.) in height.
- The maximum size opening for the individual transom lights or sidelights shall not exceed 5268 inches in area, and the maximum width or height of the individual light shall not exceed 109 3/4 inches (2788).
- 5/8" (16) glazing bead.
- Also available for borrowed lights.
- *Must be welded.

Transom Frames

Transom Frame Without Transom Bar

Wood Panel

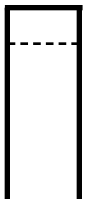

- Labeled frames may be of 16 gage, 14 gage or 12 gage steel.
- Maximum frame opening size: 4'0" (1219) x 11'0" (3353).
- Maximum door size: 4080.
- Maximum panel height: 48 1/2" (1232)-
- Jamb Depth: 4 1/2" (114) thru 20" (508).
- Maximum rating: 1 1/2 hour.
- Requires a supplemental marking that specifies:
"FOR USE ONLY WITH A CLASSIFIED TRANSOM PANEL AND ANY CLASSIFIED FIRE DOOR HAVING A RATING UP TO 1 1/2 HOURS."

Transom Frame With Transom Bar

Hollow Metal Panel

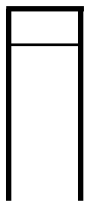

- Labeled frames may be of 16 gage, 14 gage or 12 gage steel.
- Maximum frame opening size: 4'0" (1219) x 11'0" (3353).
- Maximum door size: 4080.
- Maximum panel height: 4'0" (1219).
- Jamb Depth: 4 1/2" (114) thru 20" (508).
- Maximum rating: 3 hours.
- Maximum panel height: 34" (864)
- *Fixed mullion unit must be welded.

Transom Frame Without Transom Bar

Hollow Metal Panel

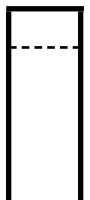

- Labeled frames may be of 16 gage, 14 gage or 12 gage steel.
- Labeled panels may be of 18 or 20 ga. steel.
- Maximum frame opening size: 4'0" (1219) x 11'0" (3353).
- Maximum door size: 4080 single.
- Jamb Depth: 4 1/2" (114) thru 20" (508).
- Maximum rating: 3 hours.
- Astragal required at bottom of panel for 3 hour rating.
- Maximum panel height: 34" (864).

Revised 9/14

LABELED FRAME SIZES AND TYPES (CONTINUED)

1 1/2 Hour Transom Sidelite Frames With Firelite or Firelite Plus Glass

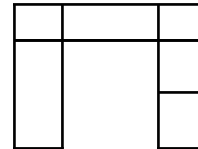

- Maximum door size 8080.
- ME/SE series profile may be 16 gage or 14 gage steel.
- MH/SH series profile may be 16 gage steel.
- Jamb depth ME/SE profile single rabbet 3" to 20", double rabbet 5 3/4" to 20".
- Jamb depth MH/SH profile single rabbet 3 1/2" to 15", double rabbet 4 1/2" to 15".
- The overall frame size shall not exceed 122" (10'2") in width and 121" (10'1") in height.
- The maximum size opening for the individual transom lights or sidelights shall not exceed 2627 sq. in. and the maximum width and height of the individual lights shall not exceed 54" and 77 3/4" respectively.
- 5/8" high glazing bead.
- Welded construction only.
- Only labeled sealant or 100% silicone sealant may be used as a glazing compound for installing Firelite.
- All types of anchors are approved. Masonry anchors may be loose or welded. Drywall anchors must be welded. All frames exceeding 8' x 9' must have anchors welded in place.
- Also available for borrowed light frames.
- Face Dimensions: Refer to U.L. or W.H. procedure manual or contact factory.

Revised 9/14

LABELED ANCHOR DETAILS

TECHNICAL DATA SHEET No. 407

Masonry Type

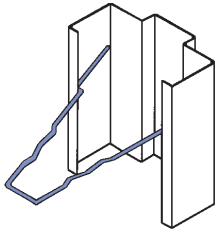

Wire Masonry
Anchor

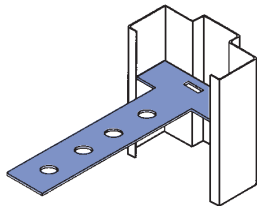

Tee Masonry
Anchor

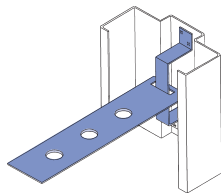

Welded On Masonry
Anchor

Wood/Steel Stud Type

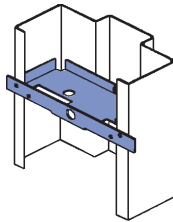

Wood Steel/Stud
Anchor
(Shipped Loose)

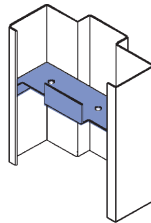

Steel Stud
Anchor
(Shipped Loose)

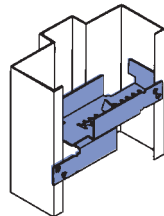

Wood/Steel Stud
Adjustable Anchor

Prepared Opening Type

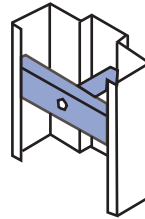

Twist in Prepared
Opening Anchor
(Shipped Loose)

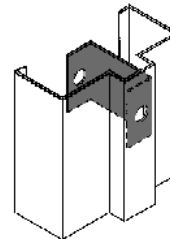

Welded On
Prepared Opening Anchor

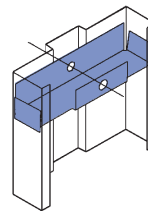

Snap-in Prepared
Opening Anchor
(Shipped Loose)

Sill Anchor Type

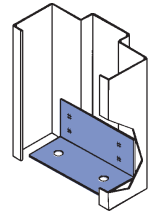

One Piece Sill Anchor
Welded On

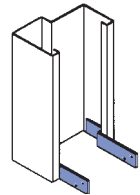

Drywall Sill Anchor

MH Intermediate Anchor

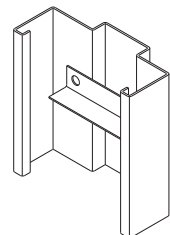

Revised 9/14

UL and WARNOCK HERSEY

1. ME Frames are not required to have welded anchors.
2. MH Frames over 7'2" must have a welded intermediate anchor.
3. ME or MH anchors can be shipped loose.

LABELED FRAME CORNER CONSTRUCTION

TECHNICAL DATA SHEET No. 408

NOTE: Labeled frames over 7'2" and all double frames require 2 - #8 x 1/2 Self Tapping Screws to each corner.

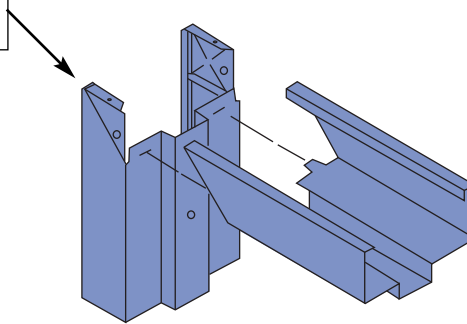

Drywall Frame
Mitered

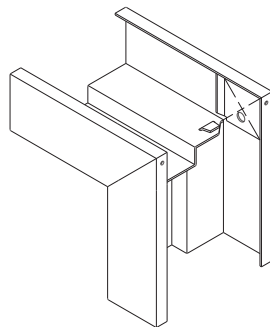

Welded
Frame

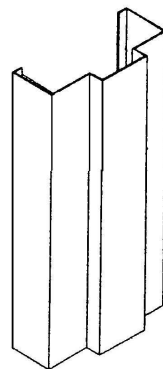

Non-Handed
Frame

Revised 9/14

LABELED TRANSOM FRAME & SIDELIGHT FRAME CONSTRUCTION

TECHNICAL DATA SHEET No. 409

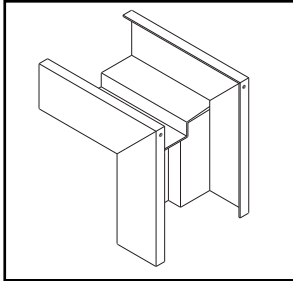

Transom Frame or
Sidelight Frame Head
Jamb Detail

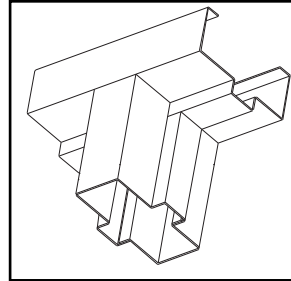

Mullion Head
Detail

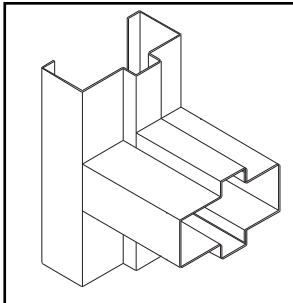

Transom Bar or
Sidelight Bar
Jamb Detail

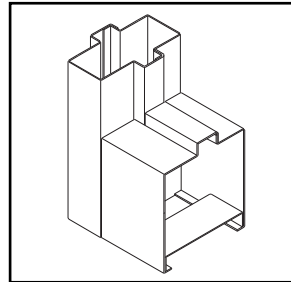

Sidelight Base
Mullion Detail

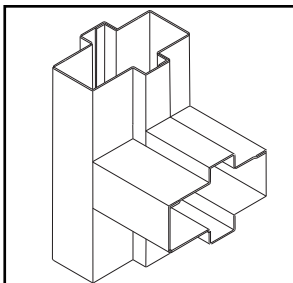

Mullion Sidelight
Bar Detail

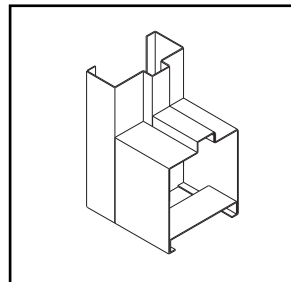

Sidelight Base
Jamb Detail

Revised 9/14

U.L. LABELED DE SERIES - 1-3/4" TEMPERATURE RISE DOOR

TECHNICAL DATA SHEET No. 410

Republic U.L. Labeled Temperature Rise Door is of steel-covered composite fire door construction and fabricated of 20 or 18 gage steel panels bonded to a mineral fiber board core. The temperature developed on the unexposed face of the door after the first 30 minutes of a fire test did not exceed 250° Fahrenheit above the ambient temperature.

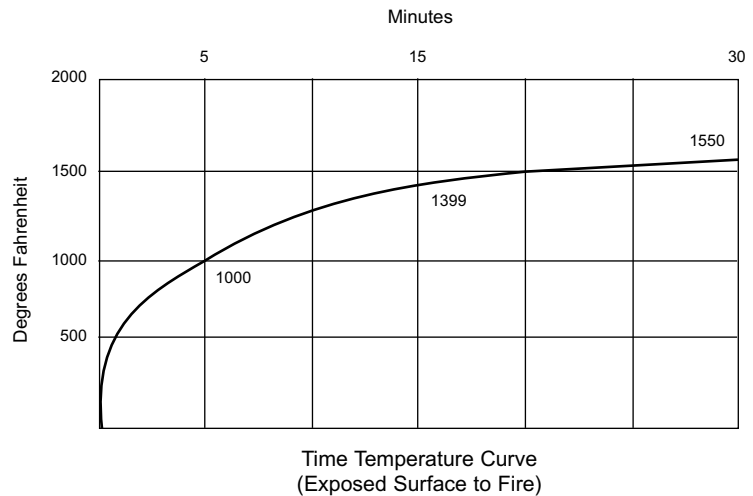
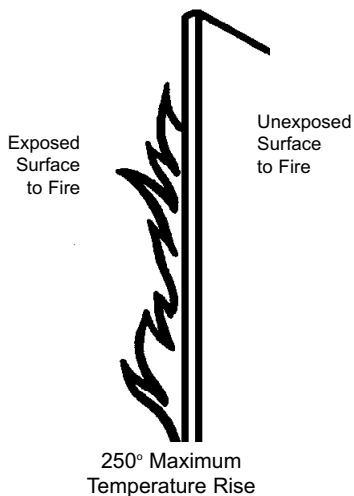

DE Series Doors shall have lock edge non-beveled and reinforced with a continuous 14 gage channel. Reinforcements for mortise or cylindrical locks shall be of an integral type and in accordance with ANSI A115 Standards.

Hinge edge is non-beveled and reinforced with a continuous 10 gage channel, projection welded at maximum 5" on centers.

Doors shall have a flush top and inverted bottom 16 gage channel projection welded at maximum 2-1/2" on centers.

Doors are thoroughly cleaned, phosphatized and receive one coat of force-cured prime paint.

Doors are individually packaged, completely covering the door to prevent damage to door or finish. The doors should be stored in an upright position, under cover at the building site on wood sills, or in a manner that will prevent rust or damage.

Glass lights are permitted in doors with up to a maximum of 100 square inches of glass area per leaf.

Revised 9/14

U.L. LABELED DE SERIES - 1-3/4" TEMPERATURE RISE DOOR CONSTRUCTION DETAILS

TECHNICAL DATA SHEET No. 411

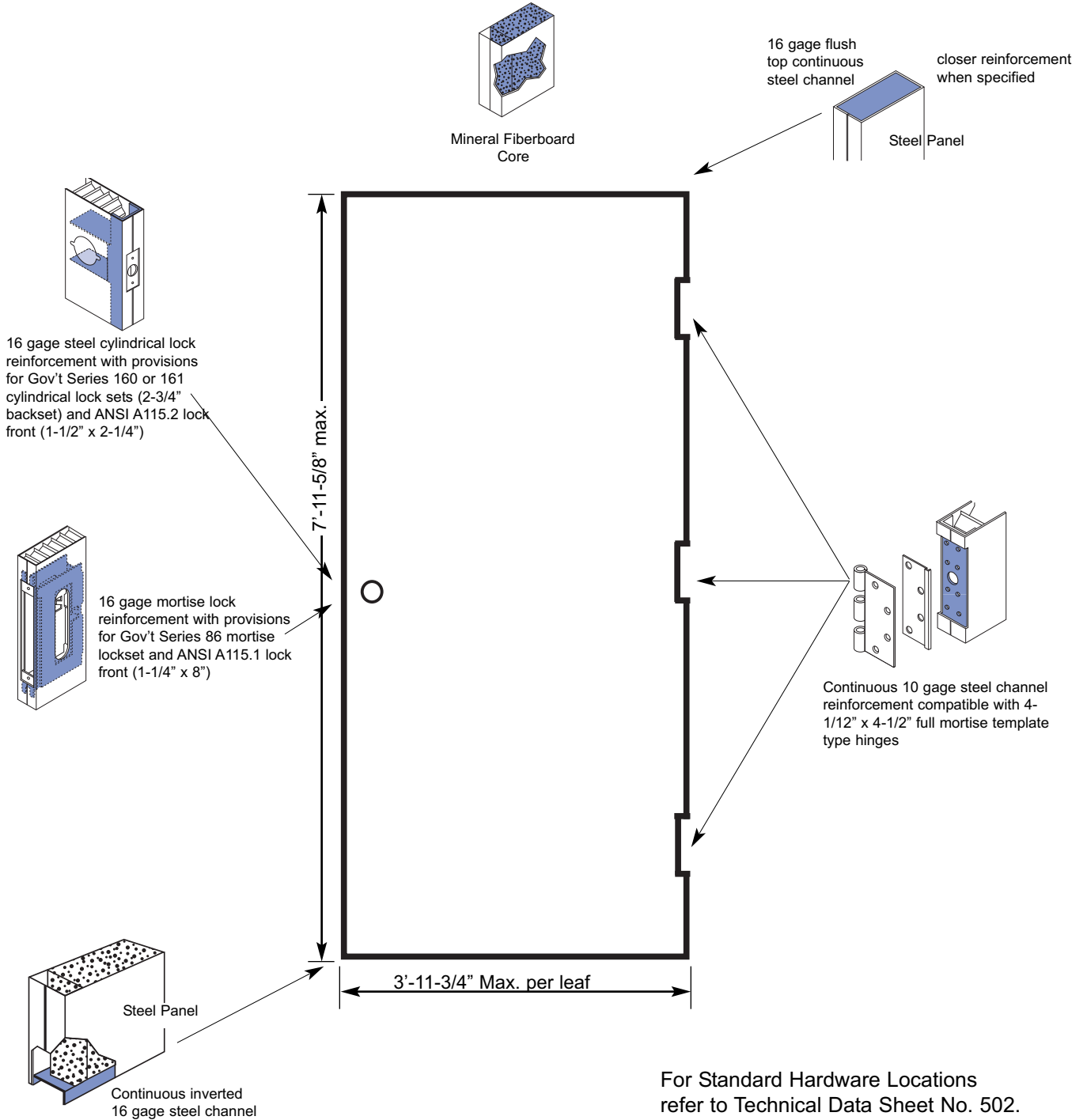

Revised 9/14

For Standard Hardware Locations
refer to Technical Data Sheet No. 502.